

Since 1992



KS A 14001:2004 / ISO 14001:2004

EULSUNG AUTO PACK CO., LTD.

| Korean Expert of Packaging Solution |



EULSUNG AUTO PACK
www.eulsung.com



EULSUNG AUTO PACK

GREETING

Eulsung Auto Pack Co., Ltd initiated its manufacturing business for machineries in Korea since 1992. We are based on world class professional technologies with extensive experiences in computer control mechatronics, high reliable production, systematic engineering and precise processing.

We have been building a good reputation for producing qualified machineries with high-quality services. As domestic & oversea enterprise, we have been exporting great packaging machineries with the best quality for food or medical manufactured from Korea to Europe, America, Asia, Oceania, Middle East, Africa and all over the world.

We always welcome your purchase inquiries and would like to answer them in all sincerity. We will do our best regarding to establishing a great relation of coexistence with our valuable customers.

Thank you for your interest in our company and machineries.

Eulsung Auto Pack Co., Ltd.



COMPANY HISTORY

- 1992** · Eulsung Auto Pack Co., Ltd Founded.
 - Developed Automatic Horizontal Flow Wrapping Machine & Automatic Tray Sealing Machine

- 1998** · Relocated and Extended Head Office & Factory in Bucheon, Korea

- 2000** · Designated the promising small and middle enterprise in Gyeonggi-do Korea

- 2002** · Established factory in Changshu, Jiangsu Province China
 - Developed Mold changeable type of automatic tray sealer

- 2004 ~ 2009** · Developed Horizontal & Vertical continuous type of Band Sealer
 - Achieved KSA 14001 & 9001, ISO 14001 & 9001

- 2010** · Remodeled and Extended Head Office & Factory in Bucheon, Korea

- 2015 ~ 2019** · Establishing Overseas Agents and Providing customer care to a lot of countries.
 - Certificates : CE, UL & etc

 - Patents : [No.10-0918823] for Automatic Tray Sealing Machine using by Ultrasonic Welding Technique & 10 more patents.

 - Participating in International Exhibitions around the world such as KOREAPACK, PROPAK ASIA & etc.

PRODUCTION LISTS

1. Horizontal flow wrapping machines

- >>> Upper reel unwinder type
- >>> Bottom reel unwinder type
- >>> Bundle packing type
- >>> Candy packing type



2. Thermoforming packing machine

- >>> Medical products



3. Automatic tray sealing machines

- >>> Intermittent type (Option : Mold changeable type)
- >>> Continuous type (Option : Mold changeable type)
- >>> Automatic rotary tray packing machine (High-speed type, Standard type)
- >>> Semi-automatic tray packing machine
- >>> M.A.P(Modified Atmospheres Packaging) tray packing machine



4. Band sealers

- >>> Horizontal types
- >>> Vertical types
- >>> Vacuum/Gas filling band sealer



5. Vacuum packing machine

6. Binding machine

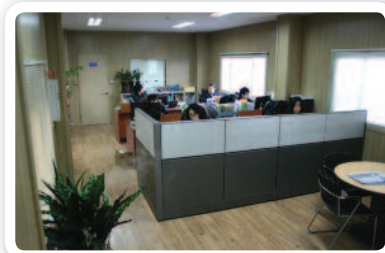

Horizontal flow wrapping machine **Upper reel unwinder type**

ESRM-101 & ESBM-101

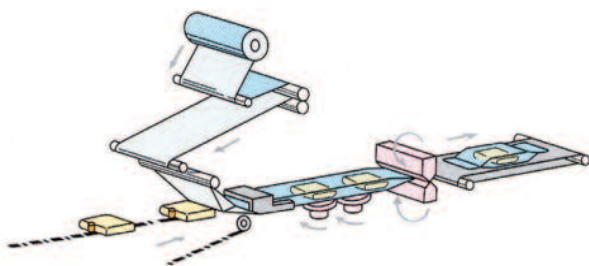
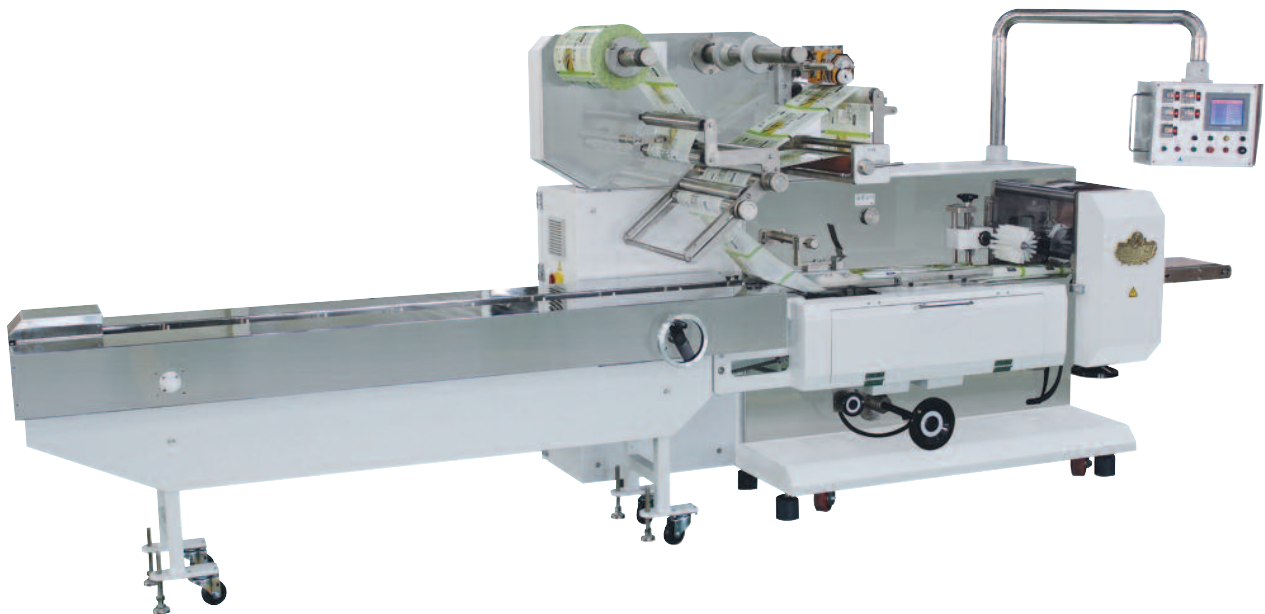

Rotary type sealer & cutter

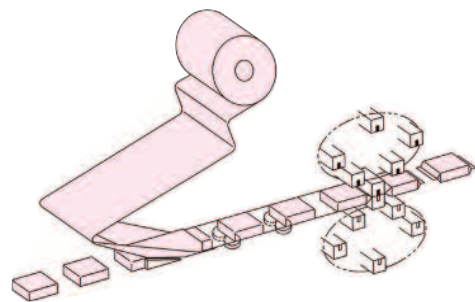

Box-motion type sealer & cutter

Applicable products

Biscuits, Chocolates, Breads, Ice creams, Frozen foods, Lavers, Sponges, Soaps, Wet tissues, Plastic tube products, Condoms, Medical products and etc

Specification

- ››› Rotary type capacity : Max. 250cycles/min (It depends on product)
- ››› Box-motion type capacity : Max. 100cycles/min (It depends on product)
- ››› Power voltage : 220V 3P or 380V 3P
- ››› Power consumption : 5KW

Options

- ››› Date printer
- ››› Shrink packing
- ››› Servo motor system
- ››› Automatic film splicer
- ››› Gusset packing device
- ››› Automatic feeding system
- ››› Stainless steel are used in every parts of the machine



Mini flow wrapper (Upper film reel)

ESRM-101(M) (Mini-Induction motor)
ESRM-101(MS) (Mini-Servo motor)



Made in Korea

*The design and technology rights of this machine are in EulSung Auto Pack Machinery Co.,Ltd.

Features

- >>> Compact design and it has all the good features as bigger machine
- >>> With regular motor drive : Simple use. Adjustable packing size by manual.
- >>> With servo motor drive : Memorable various packaging conditions by touch panel.

Applicable products

Biscuits, Chocolates, Breads, Ice creams, Frozen foods, Lavers, Sponges, Soaps, Wet tissues, Plastic tube products, Condoms, Medical products and etc

Specifications

Capacity	Max. 60packs/min.	Cutter	Rotary type
Packing size	L120 xW120 xH40mm	Electric	220V 1P .50A
Film size(mm)	Roll width Max.340mm	PWR.consumption	5Kw
	Max. cuttable L250mm	Weight	800Kg (1763lb)
Dirving motor	101(M) Induction motor	Dimension(Cm)	W86 x L210 x H135
	101(MS) Servo motor		

*Specifications subject to change.

Options

- >>> Date coder(Printer not included)
- >>> Automatic film splicer
- >>> Automatic infeeding system
- >>> STU(SUS) body and frame



Mini flow wrapper (Bottom film reel)

ESRM-102(M) (Mini-Induction motor)
ESRM-102(MS) (Mini-Servo motor)

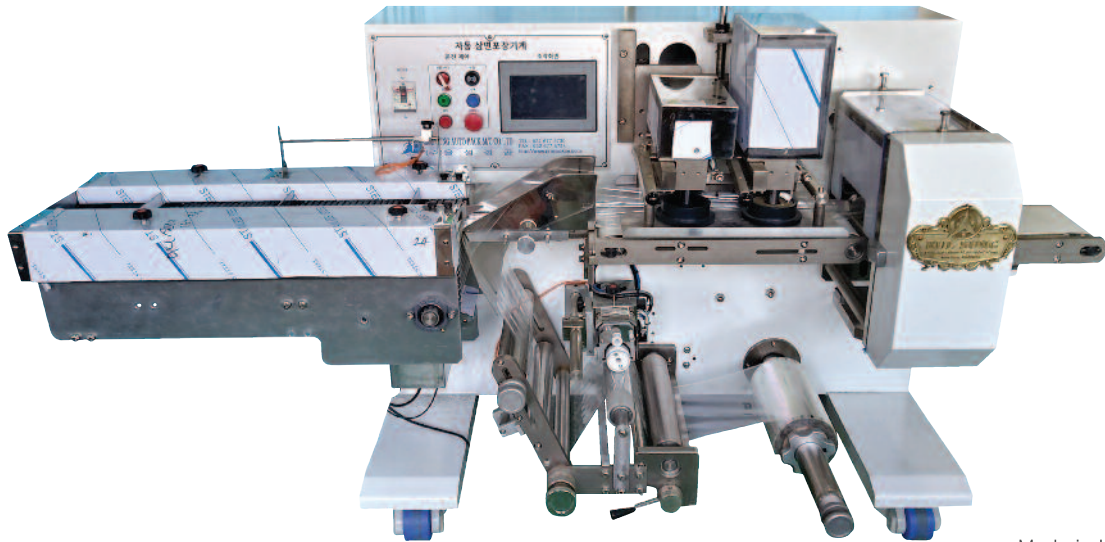

Made in Korea

*The design and technology rights of this machine are in EulSung Auto Pack Machinery Co.,Ltd.

Features

- >>> Compact design and it has all the good features as bigger machine
- >>> With regular motor drive : Simple use. Adjustable packing size by manual.
- >>> With servo motor drive : Memorable various packaging conditions by touch panel.

Applicable products

Biscuits, Chocolates, Breads, Ice creams, Frozen foods, Lavers, Sponges, Soaps, Wet tissues, Plastic tube products, Condoms, Medical products and etc

Specifications

Capacity	Max. 60packs/min.	Cutter	Rotary type
Packing size	L120 xW120 xH40mm	Electric	220V 1P .50A
Film size(mm)	Roll width Max.340mm	PWR.consumption	5Kw
	Max. cuttable L250mm	Weight	800Kg (1763lb)
Dirving motor	102(M) Induction motor	Dimension(Cm)	W95 x L200 x H108
	102(MS) Servo motor		

*Specifications subject to change.

Options

- >>> Date coder(Printer not included)
- >>> Automatic film splicer
- >>> Automatic infeeding system
- >>> STU(SUS) body and frame



Horizontal flow wrapping machine **Bottom reel unwinder type**

ESBM-102(S)

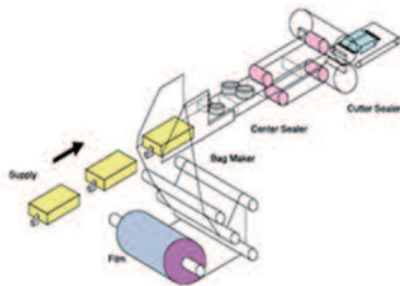

Rotary type sealer & cutter

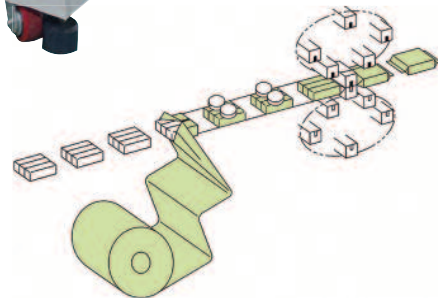

Box-motion type sealer & cutter

Applicable products

Biscuits, Chocolates, Breads, Ice creams, Frozen foods, Lavers, Sponges, Soaps, Fish cakes, Condoms, Medical products and etc.

Specification

- ››› Rotary type capacity : Max. 250cycles/min (It depends on product)
- ››› Box-motion type capacity : Max. 80cycles/min (It depends on product)
- ››› Power voltage : 220V 3P or 380V 3P
- ››› Power consumption : 5KW

Options

- ››› Date printer
- ››› Shrink packing
- ››› Servo motor system
- ››› Automatic film splicer
- ››› Gusset packing device
- ››› Automatic feeding system
- ››› Stainless steel are used in every parts of the machine



Horizontal flow wrapping machine **Bundle packing**

ESBM-102B & ESBS-102B

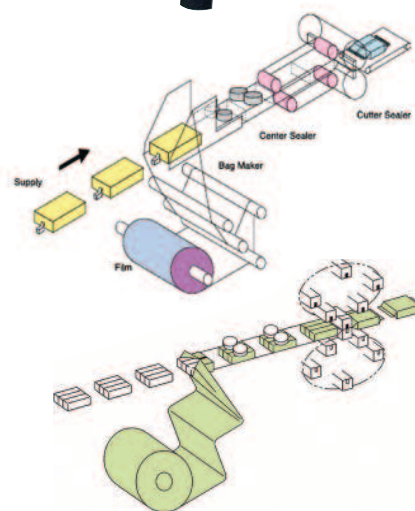
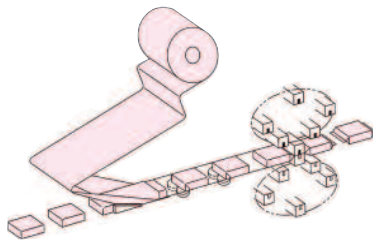
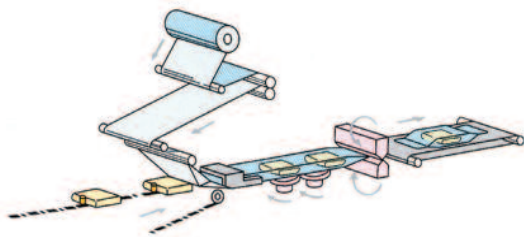

Applicable products

Bundle packing type products

Specification

- >>> Capacity : Max. 60packs/min (It depends on product)
- >>> Power voltage : 220V 3P or 380V 3P
- >>> Power consumption : 5KW

Options

- >>> Date printer
- >>> Gusset packing device
- >>> Servo motor system
- >>> Automatic feeding system
- >>> Stainless steel are used in every parts of the machine



Horizontal flow wrapping machine **Candy packing**

ESCM-101

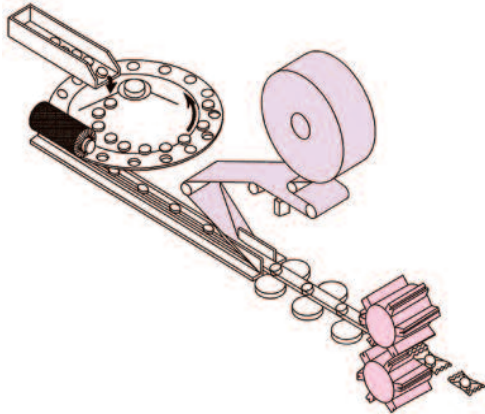

Applicable products

Candy type products

Specification

- ››› Capacity : Max. 600~800cycles/min (It depends on product)
- ››› Rotary type of sealer & cutter
- ››› Power voltage : 220V 3P or 380V 3P
- ››› Power consumption : 5KW

Options

- ››› 4~6cutter
- ››› Circle feeding device
- ››› Automatic film splicer
- ››› Stainless steel are used in every parts of the machine



Thermoforming packing machine

ESB-501

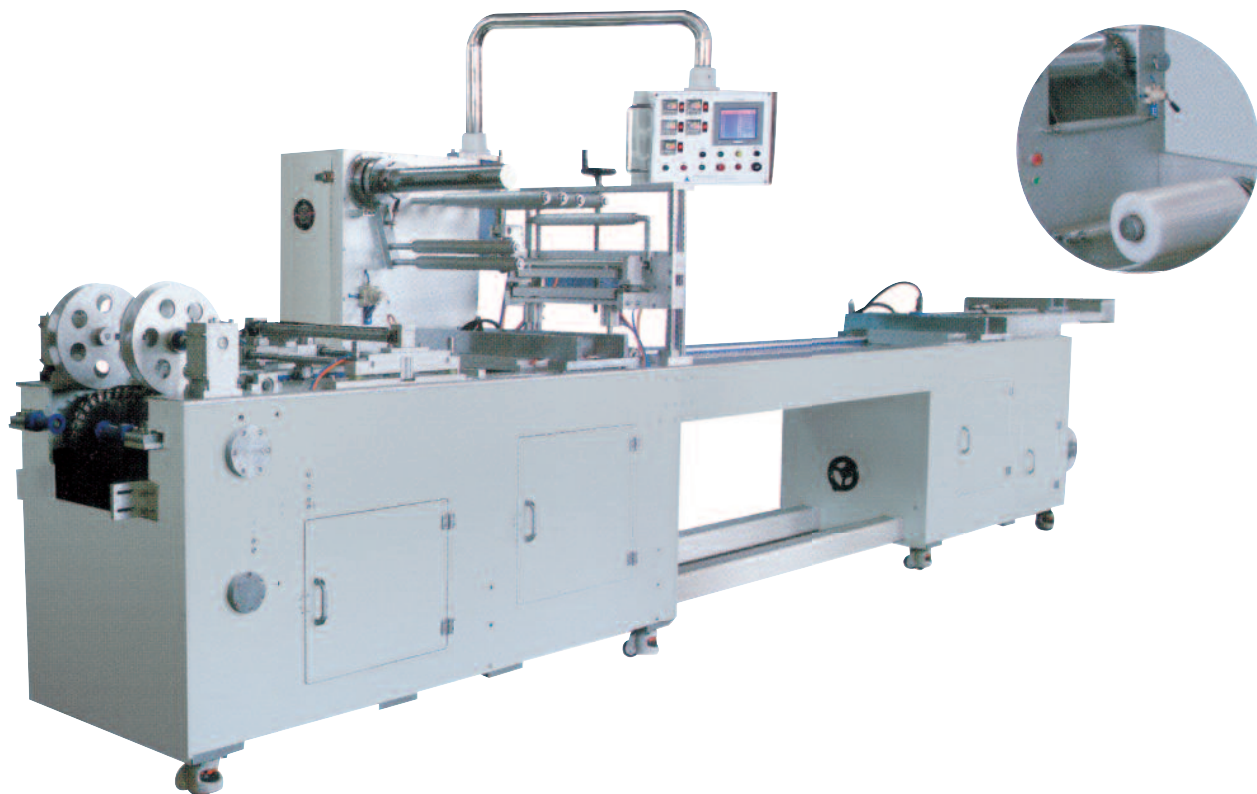

Applicable products

Syringes, Medicines, Medical connect tubes, Tooth brushes, Disposable products and etc.

Specification

›› Capacity : Max. 16cycles/min (It depends on product)

Feature

- ›› Thermoforming is available
- ›› Mold size adjustment is available
- ›› Soft & Hard products packing is available
- ›› Frame's all materials are Stainless steel and Aluminum



Automatic tray sealing machine **Intermittent type**

ESCS-201



Applicable products

Various cup or tray packing products such as Tofu, Instant cup noodles, Water, Liquids, Pastes, Yogurts, Puddings, Sauces, Meats, Vegetables, Sandwiches, Coffee creamers, Pizza, Rice porridges, Dried fruits, Cooked rice, Contact lenses and etc.

Specification

››› Capacity : Max. 20cycles/min per lane (It depends on product)

Options

- ››› Dust collector
- ››› Automatic capping device
- ››› Solid & Liquid filling device
- ››› Automatic tray feeding device
- ››› Able to design & plan all packing production line
- ››› M.A.P(Modified Atmospheres Packaging) gas filling device
- ››› Mold changeable type (It takes about 30 minutes to change mold)
- ››› Date printer (Carbon paper type, Inkjet type, thermal transfer printing type)

Feature

- ››› Servo motor system
- ››› Control by PLC system
- ››› HACCP standard product
- ››› Water cleaning is available
- ››› Hard anodizing to prevent rust
- ››› Sealing bar & Knife position correction
- ››› Frame's all materials are Stainless steel and Aluminum



Automatic tray sealing machine **Continuous type**

ESCM-201S



Applicable products

Various cup or tray packing products such as Tofu, Instant cup noodles, Water, Liquids, Pastes, Yogurts, Puddings, Sauces, Meats, Vegetables, Sandwiches, Coffee Creamers, Pizza, Rice porridges, Dried fruits, Contact lenses and etc.

Specification

▶▶▶ Capacity : Max. 40cycles/min per lane (It depends on product)

Options

- ▶▶▶ Dust collector
- ▶▶▶ Solid & Liquid filling device
- ▶▶▶ Automatic tray feeding device
- ▶▶▶ Able to design & plan all packing production line
- ▶▶▶ M.A.P(Modified Atmospheres Packaging) gas filling device
- ▶▶▶ Mold changeable type (It takes about 30 minutes to change mold)
- ▶▶▶ Date printer (Carbon paper type, Inkjet type, thermal transfer printing type)

Feature

- ▶▶▶ Control by PLC system
- ▶▶▶ HACCP standard product
- ▶▶▶ Water cleaning is available
- ▶▶▶ Continuous system by Cam
- ▶▶▶ Hard anodizing to prevent rust
- ▶▶▶ Sealing bar & Knife position correction
- ▶▶▶ All frames are made by Stainless steel and Aluminum



Automatic rotary tray sealing machine **High-speed type, Standard type**

ESHR-301H

High-speed automatic rotary tray sealing machine

Applicable products

Various cup or tray packing products

Specification

- Capacity : Max. 30cycles/min
(It depends on mold holes & size)
- Power voltage : 220V 3P or 380V 3P
- Power consumption : 10KW

Options

- Mold changeable type
- Pre-cut lid or roll film sealing
- M.A.P(Modified Atmospheres Packaging) gas filling device

Feature

- Occupy smaller space than lane type of automatic tray packing machine



ESHR-301

Standard automatic rotary tray sealing machine

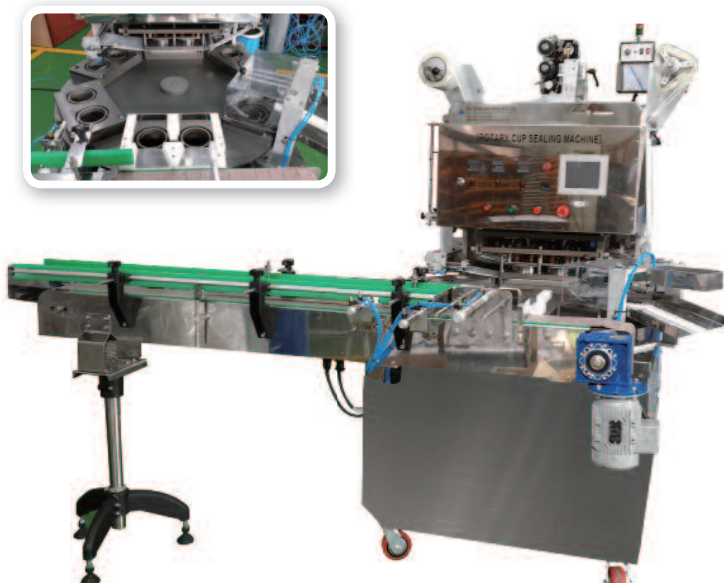
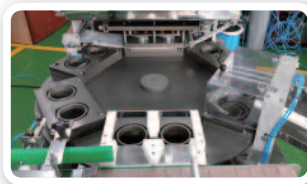

Applicable products

Various cup or tray packing products

Specification

- Capacity : Max 10~12cycles/min
(It depends on mold holes & size)
- Power voltage : 220V 3P or 380V 3P
- Power consumption : 2KW

Options

- Mold changeable type
- Pre-cut lid or roll film sealing
- M.A.P(Modified Atmospheres Packaging) gas filling device

Feature

- Manual feeding
- Occupy smaller space than lane type of automatic tray packing machine

Semiautomatic tray sealing machine & M.A.P (Modified Atmospheres Packaging) tray sealing machine

ESHSA-401

Semiautomatic tray sealing machine

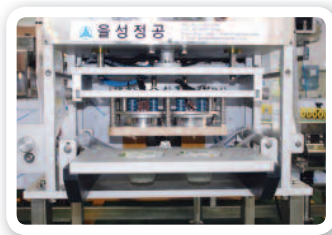

ESHSA-401MAP

M.A.P (Modified Atmospheres Packaging) tray sealing machine

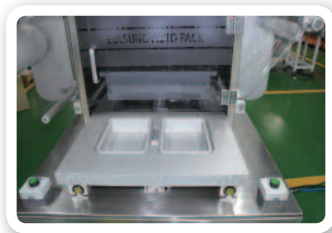

Applicable products

Various cup or tray packing products

Specification

- ▶▶▶ Semiautomatic tray sealing machine capacity :
Max. 5~6cycles/min
(It depends on mold holes & size)
- ▶▶▶ M.A.P tray sealing machine capacity :
Max. 3~5cycles/min
(It depends on mold holes & size)
- ▶▶▶ Power voltage : 220V AC. 50~60Hz
- ▶▶▶ Power consumption : 5KW

Options

- ▶▶▶ Mold changeable type

Feature

- ▶▶▶ Manual feeding
- ▶▶▶ Occupy smaller space than lane type of automatic tray packing machine

Horizontal type band sealers

ESPM-100



ESPM-100P



ESPM-100PA



ESPM-100PD

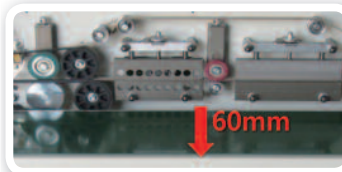

*Conveyor height can be adjusted up to 60mm



*Conveyor angle can be adjusted up to 15degrees down

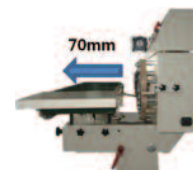

*Conveyor can be extended up to 70mm

	ESPM-100	ESPM-100P	ESPM-100PA	ESPM-100PD
Power voltage	220V 1P 50/60Hz	220V 1P 50/60Hz	220V 1P 50/60Hz	220V 1P 50/60Hz
Power consumption	860W	1040W	1410W	1740W
Sealing width	10mm	10mm	10mm	10mm
Capacity	Max. 15m/min	Max. 15m/min	Max. 15m/min	Max. 15m/min
Sealing temperature	0-400°C	0-400°C	0-400°C	0-400°C
Dimension	W465 X L1230 X H1050	W465 X L1230 X H1050	W465 X L1230 X H1050	W465 X L1630 X H1050
Weight	73Kg	78Kg	92Kg	95Kg

Vertical type band sealers

ESPM-200



ESPM-200P



ESPM-200PD

Conveyor height can be adjusted up to 500mm for pouches



	ESPM-200	ESPM-200P	ESPM-200PD
Power voltage	220V 1P 50/60Hz	220V 1P 50/60Hz	220V 1P 50/60Hz
Power consumption	920W	1100W	1740W
Sealing width	10mm	10mm	10mm
Sealing temperature	0-400°C	0-400°C	0-400°C
Capacity	Max. 15m/min	Max. 15m/min	Max. 15m/min
Dimension	W530 X L1630 X H1440	W530 X L1630 X H1440	W530 X L1770 X H1440
Weight	111Kg	116Kg	126Kg

Horizontal vacuum/gas filling band sealer

ESPM-100VGP



Specification

- ››› Use German Busch Vacuum Pumps and Systems' vacuum pump
- ››› Power Voltage : 220V 1Phase 50/60HZ
- ››› Power consumption : 1340W
- ››› Teflon belt : W220 X L3140
- ››› Conveyor belt : W220 X L3140
- ››› Dimension (mm): W605 X L1680 X H1065
- ››› Weight : 160Kg

Feature

- ››› Vacuum device
- ››› Power saving timer function
- ››› Able to adjust vacuum & gas filling time
- ››› Carbon paper type of date printer device
- ››› Vacuum, gas filling, printing is available at one time
- ››› Higher capacity than standard vacuum packing machine
- ››› M.A.P(Modified Atmospheres Packaging) gas filling device



Vacuum packing machine

ESVCM

Specification

- >>> Vacuum cycle : 2~3cycles/min
- >>> Power voltage : 220V/380V/3phases
- >>> Power consumption : 5.5Kw
- >>> Material : Stainless steel
- >>> Use German Busch Vacuum Pumps and Systems' vacuum pump
- >>> Dimension(Vacuum chamber) :
L810mm X W690mm X H170mm
- >>> Machine Dimension :
L1,700mm X W1,000mm X H1,050mm
- >>> Weight : 330Kg



Binding machine



Specification

- >>> Capacity : Max. 25~30cycles/min (It depends on operating skill)



EULSUNG AUTO PACK CO., LTD.



www.eulsung.com

Eulsung Auto Pack Co., Ltd.

Korea Head office/Factory

78, Seokcheon-ro 494gil, Bucheon-si, Korea (Post code : 14446)

Tel : +82-32-677-5730~3 Fax : +82-32-677-5734

Website : www.eulsung.com

E-mail : eulsung@eulsung.com

China Branch/Factory

No. 8 of Qigan Second Rd, Xushi Industrial Area, Dongbang, Changshu city,
Jiangsu Province China

Tel : +86-512-5267-4348/4338/4358 Fax : +86-512-5267-4378

